

ADC12020

12-Bit, 20 MSPS, 185 mW A/D Converter with Internal Sample-and-Hold

General Description

The ADC12020 is a monolithic CMOS analog-to-digital converter capable of converting analog input signals into 12-bit digital words at 20 Megasamples per second (MSPS), minimum. This converter uses a differential, pipeline architecture with digital error correction and an on-chip sample-and-hold circuit to minimize die size and power consumption while providing excellent dynamic performance. Operating on a single 5V power supply, this device consumes just 185 mW at 20 MSPS, including the reference current. The Power Down feature reduces power consumption to 40 mW.

The differential inputs provide a full scale input swing equal to $2V_{REF}$ with the possibility of a single-ended input. Full use of the differential input is recommended for optimum performance. For ease of use, the buffered, high impedance, single-ended reference input is converted on-chip to a differential reference for use by the processing circuitry. Output data format is 12-bit offset binary.

This device is available in the 32-lead LQFP package and will operate over the industrial temperature range of -40°C to $+85^{\circ}\text{C}$.

Features

- Internal sample-and-hold
- Outputs 2.35V to 5V compatible
- Pin compatible with ADC12010, ADC12040, ADC12L063 and ADC12L066
- TTL/CMOS compatible input/outputs
- Power down mode
- On-chip reference buffer

Key Specifications

- | | |
|-------------------------------|----------------------|
| ■ Resolution | 12 Bits |
| ■ Conversion Rate | 20 MSPS (min) |
| ■ DNL | ± 0.35 LSB (typ) |
| ■ ENOB ($f_{IN} = 10.1$ MHz) | 11.3 bits (typ) |
| ■ Supply Voltage | +5V $\pm 5\%$ |
| ■ Power Consumption, 20 MHz | 185 mW (typ) |

Applications

- Image Processing Front End
- Instrumentation
- PC-Based Data Acquisition
- Fax Machines
- Waveform Digitizers
- Sonar/Radar
- DSP Front Ends

Connection Diagram

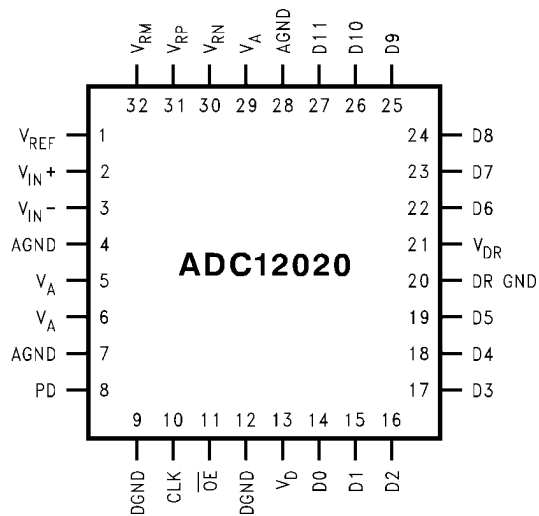

20051701

Ordering Information

| Industrial ($-40^{\circ}\text{C} \leq T_A \leq +85^{\circ}\text{C}$) | Package |
|--|---------------------------|
| ADC12020CIVY | 32 Pin LQFP |
| ADC12020CIVYX | 32 Pin LQFP Tape and Reel |
| ADC12040EVAL | 40 MspS Evaluation Board |

Block Diagram

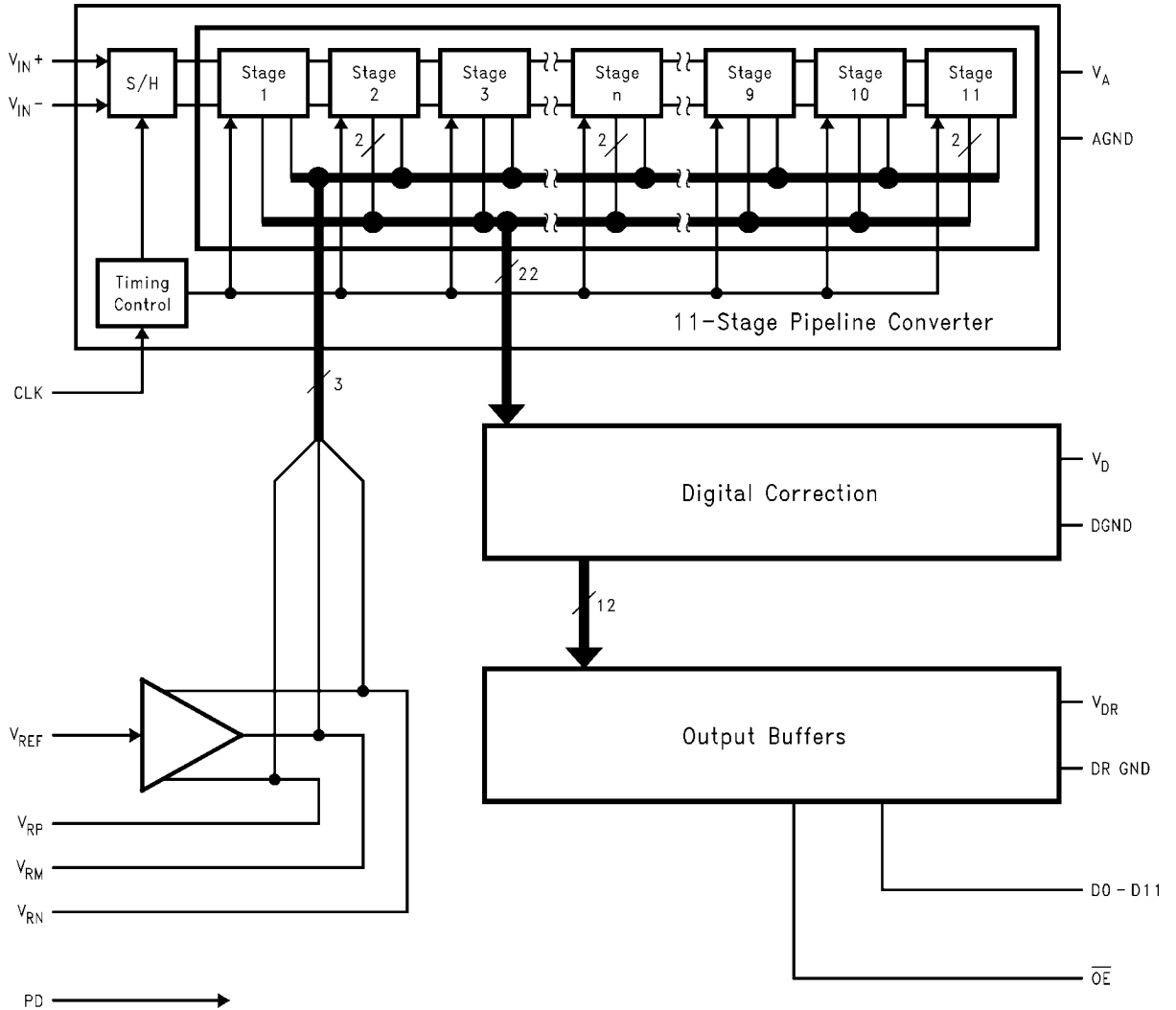

20051702

Pin Descriptions and Equivalent Circuits

| Pin No. | Symbol | Equivalent Circuit | Description |
|--------------------|-----------------|--------------------|---|
| ANALOG I/O | | | |
| 2 | V_{IN+} | | Non-Inverting analog signal Input. With a 2.0V reference voltage, the differential input signal level is 2.0 V_{P-P} centered on V_{CM} . |
| 3 | V_{IN-} | | Inverting analog signal Input. With a 2.0V reference voltage the ground-referenced input signal level is 2.0 V_{P-P} centered on V_{CM} . This pin may be connected to V_{CM} for single-ended operation, but a differential input signal is required for best performance. |
| 1 | V_{REF} | | Reference input. This pin should be bypassed to AGND with a 0.1 μF monolithic capacitor. V_{REF} is 2.0V nominal and should be between 1.0V to 2.2V. |
| 31 | V_{RP} | | These pins are high impedance reference bypass pins. Connect a 0.1 μF capacitor from each of these pins to AGND. DO NOT LOAD these pins. |
| 32 | V_{RM} | | |
| 30 | V_{RN} | | |
| DIGITAL I/O | | | |
| 10 | CLK | | Digital clock input. The range of frequencies for this input is 100 kHz to 30 MHz (typical) with guaranteed performance at 20 MHz. The input is sampled on the rising edge of this input. |
| 11 | \overline{OE} | | \overline{OE} is the output enable pin that, when low, enables the TRI-STATE® data output pins. When this pin is high, the outputs are in a high impedance state. |
| 8 | PD | | PD is the Power Down input pin. When high, this input puts the converter into the power down mode. When this pin is low, the converter is in the active mode. |
| 14–19, 22–27 | D0–D11 | | Digital data output pins that make up the 12-bit conversion results. D0 is the LSB, while D11 is the MSB of the offset binary output word. Output levels are TTL/CMOS compatible. |

| Pin No. | Symbol | Equivalent Circuit | Description |
|----------------------|----------|--------------------|--|
| ANALOG POWER | | | |
| 5, 6, 29 | V_A | | Positive analog supply pins. These pins should be connected to a quiet +5V voltage source and bypassed to AGND with 0.1 μ F monolithic capacitors located within 1 cm of these power pins, and with a 10 μ F capacitor. |
| 4, 7, 28 | AGND | | The ground return for the analog supply. |
| DIGITAL POWER | | | |
| 13 | V_D | | Positive digital supply pin. This pin should be connected to the same quiet +5V source as is V_A and bypassed to DGND with a 0.1 μ F monolithic capacitor in parallel with a 10 μ F capacitor, both located within 1 cm of the power pin. |
| 9, 12 | DGND | | The ground return for the digital supply. |
| 21 | V_{DR} | | Positive digital supply pin for the ADC12020's output drivers. This pin should be connected to a voltage source of +2.35V to +5V and be bypassed to DR GND with a 0.1 μ F monolithic capacitor. If the supply for this pin is different from the supply used for V_A and V_D , it should also be bypassed with a 10 μ F tantalum capacitor. V_{DR} should never exceed the voltage on V_D . All bypass capacitors should be located within 1 cm of the supply pin. |
| 20 | DR GND | | The ground return for the digital supply for the ADC12020's output drivers. This pin should be connected to the system digital ground, but not be connected in close proximity to the ADC12020's DGND or AGND pins. See Section 5 (Layout and Grounding) for more details. |

Absolute Maximum Ratings (Notes 1, 2)

If Military/Aerospace specified devices are required, please contact the National Semiconductor Sales Office/Distributors for availability and specifications.

| | |
|---|---|
| V_A, V_D | 6.5V |
| V_{DR} | $\leq V_D + 0.3V$ |
| $ V_A - V_D $ | $\leq 100\text{ mV}$ |
| Voltage on Any Input or Output Pin | $-0.3V$ to $(V_A$ or $V_D + 0.3V)$ |
| Input Current at Any Pin (Note 3) | $\pm 25\text{ mA}$ |
| Package Input Current (Note 3) | $\pm 50\text{ mA}$ |
| Package Dissipation at $T_A = 25^\circ\text{C}$ | See (Note 4) |
| ESD Susceptibility | |
| Human Body Model (Note 5) | 2500V |
| Machine Model (Note 5) | 250V |
| Soldering Temperature, Infrared, 10 sec. (Note 6) | 235°C |
| Storage Temperature | -65°C to $+150^\circ\text{C}$ |

Operating Ratings (Notes 1, 2)

| | |
|-----------------------------------|---|
| Operating Temperature | $-40^\circ\text{C} \leq T_A \leq +85^\circ\text{C}$ |
| Supply Voltage (V_A, V_D) | +4.75V to +5.25V |
| Output Driver Supply (V_{DR}) | +2.35V to V_D |
| V_{REF} Input | 1.0V to 2.4V |
| CLK, PD, $\overline{\text{OE}}$ | $-0.05V$ to $(V_D + 0.05V)$ |
| V_{IN} Input | $-0V$ to $(V_A - 0.5V)$ |
| V_{CM} | 1.0V to 4.0V |
| IAGND–DGNDI | $\leq 100\text{mV}$ |

Package Thermal Resistance

| Package | θ_{JA} |
|--------------|---------------|
| 32-Lead LQFP | 79°C / W |

Converter Electrical Characteristics

Unless otherwise specified, the following specifications apply for AGND = DGND = DR GND = 0V, $V_A = V_D = +5V$, $V_{DR} = +3.0V$, PD = 0V, $V_{REF} = +2.0V$, $f_{CLK} = 20\text{ MHz}$, $t_r = t_f = 3\text{ ns}$, $C_L = 25\text{ pF/pin}$. **Boldface limits apply for $T_J = T_{MIN}$ to T_{MAX} :** all other limits $T_A = T_J = 25^\circ\text{C}$ (Notes 7, 8, 9)

| Symbol | Parameter | Conditions | Typical (Note 10) | Limits (Note 10) | Units (Limits) |
|--|--------------------------------------|---|----------------------|------------------------------|------------------------|
| STATIC CONVERTER CHARACTERISTICS | | | | | |
| | Resolution with No Missing Codes | | | 12 | Bits (min) |
| INL | Integral Non Linearity (Note 11) | | ± 0.55 | +1.7 -1.4 | LSB (max) LSB (min) |
| DNL | Differential Non Linearity | | ± 0.35 | +0.9 -1.0 | LSB (max) LSB (min) |
| GE | Gain Error | | ± 0.05 | 2.9 | %FS (max) |
| | Offset Error ($V_{IN+} = V_{IN-}$) | | -0.04 | ± 1.75 | %FS (max) |
| | Under Range Output Code | | 0 | 0 | |
| | Over Range Output Code | | 4095 | 4095 | |
| DYNAMIC CONVERTER CHARACTERISTICS | | | | | |
| FPBW | Full Power Bandwidth | 0 dBFS Input, Output at -3 dB | 100 | | MHz |
| SNR | Signal-to-Noise Ratio | $f_{IN} = 1\text{ MHz}, V_{IN} = -0.5\text{ dBFS}$ | 70 | | dB |
| | | $f_{IN} = 4.4\text{ MHz}, V_{IN} = -0.5\text{ dBFS}$ | 70 | | dB |
| | | $f_{IN} = 10.1\text{ MHz}, V_{IN} = -0.5\text{ dBFS}$ | 70 | 67 | dB (min) |
| SINAD | Signal-to-Noise and Distortion | $f_{IN} = 1\text{ MHz}, V_{IN} = -0.5\text{ dBFS}$ | 70 | | dB |
| | | $f_{IN} = 4.4\text{ MHz}, V_{IN} = -0.5\text{ dBFS}$ | 70 | | dB |
| | | $f_{IN} = 10.1\text{ MHz}, V_{IN} = -0.5\text{ dBFS}$ | 69 | 67 | dB (min) |
| ENOB | Effective Number of Bits | $f_{IN} = 1\text{ MHz}, V_{IN} = -0.5\text{ dBFS}$ | 11.3 | | dB |
| | | $f_{IN} = 4.4\text{ MHz}, V_{IN} = -0.5\text{ dBFS}$ | 11.3 | | dB |
| | | $f_{IN} = 10.1\text{ MHz}, V_{IN} = -0.5\text{ dBFS}$ | 11.3 | 10.8 | dB (min) |
| THD | Total Harmonic Distortion | $f_{IN} = 1\text{ MHz}, V_{IN} = -0.5\text{ dBFS}$ | -83 | | dB |
| | | $f_{IN} = 4.4\text{ MHz}, V_{IN} = -0.5\text{ dBFS}$ | -83 | | dB |
| | | $f_{IN} = 10.1\text{ MHz}, V_{IN} = -0.5\text{ dBFS}$ | -83 | -74 | dB (min) |
| | | $f_{IN} = 10.1\text{ MHz}, V_{IN} = -0.5\text{ dBFS}$ | +25°C +85°C | -74 -71 | dB (min) dB (min) |

| Symbol | Parameter | Conditions | Typical (Note 10) | Limits (Note 10) | Units (Limits) |
|--------|-----------------------------|---|----------------------|---------------------|-------------------|
| SFDR | Spurious Free Dynamic Range | $f_{IN} = 1 \text{ MHz}, V_{IN} = -0.5 \text{ dBFS}$ | 86 | | dB |
| | | $f_{IN} = 4.4 \text{ MHz}, V_{IN} = -0.5 \text{ dBFS}$ | 86 | | dB |
| | | $f_{IN} = 10.1 \text{ MHz},$ $V_{IN} = -0.5 \text{ dBFS}$ | 86 | 71 | dB (min) |
| | | | | 68 | dB (min) |
| IMD | Intermodulation Distortion | $f_{IN} = 4.7 \text{ MHz}$ and 5.3 MHz , each = -7 dBFS | -73 | | dBFS |

REFERENCE AND ANALOG INPUT CHARACTERISTICS

| Symbol | Parameter | Conditions | Typical (Note 10) | Limits (Note 10) | Units (Limits) |
|-----------|--|--|----------------------|---------------------|-------------------|
| V_{CM} | Common Mode Input Voltage | | $V_A/2$ | | V |
| C_{IN} | V_{IN} Input Capacitance (each pin to GND) | $V_{IN} = 2.5 \text{ Vdc} + 0.7 V_{rms}$ | (CLK LOW) | 8 | pF |
| | | | (CLK HIGH) | 7 | pF |
| V_{REF} | Reference Voltage (Note 13) | | 2.00 | 1.0 | V (min) |
| | | | | 2.4 | V (max) |
| | Reference Input Resistance | | 100 | | MΩ(min) |

DC and Logic Electrical Characteristics

Unless otherwise specified, the following specifications apply for AGND = DGND = DR GND = 0V, $V_A = V_D = +5V$, $V_{DR} = +3.0V$, PD + 0V, $V_{REF} = +2.0V$, $f_{CLK} = 20 \text{ MHz}$, $t_r = t_f = 3 \text{ ns}$, $C_L = 25 \text{ pF/pin}$. **Boldface limits apply for $T_J = T_{MIN}$ to T_{MAX}** ; all other limits $T_A = T_J = 25^\circ\text{C}$ (Notes 7, 8, 9)

| Symbol | Parameter | Conditions | Typical (Note 10) | Limits (Note 10) | Units (Limits) |
|--|---------------------------|-----------------|----------------------|---------------------|-------------------|
| CLK, PD, \overline{OE} DIGITAL INPUT CHARACTERISTICS | | | | | |
| $V_{IN(1)}$ | Logical "1" Input Voltage | $V_D = 5.25V$ | | 2.0 | V (min) |
| $V_{IN(0)}$ | Logical "0" Input Voltage | $V_D = 4.75V$ | | 1.0 | V (max) |
| $I_{IN(1)}$ | Logical "1" Input Current | $V_{IN} = 5.0V$ | 10 | | μA |
| $I_{IN(0)}$ | Logical "0" Input Current | $V_{IN} = 0V$ | -10 | | μA |
| C_{IN} | Digital Input Capacitance | | 5 | | pF |

D0–D11 DIGITAL OUTPUT CHARACTERISTICS

| Symbol | Parameter | Conditions | Typical (Note 10) | Limits (Note 10) | Units (Limits) |
|--------------|-------------------------------------|---|----------------------|---------------------|-------------------|
| $V_{OUT(1)}$ | Logical "1" Output Voltage | $I_{OUT} = -0.5 \text{ mA}$ | $V_{DR} = 2.5V$ | 2.3 | V (min) |
| | | | $V_{DR} = 3V$ | 2.7 | V (min) |
| $V_{OUT(0)}$ | Logical "0" Output Voltage | $I_{OUT} = 1.6 \text{ mA}, V_{DR} = 3V$ | | 0.4 | V (max) |
| I_{OZ} | TRI-STATE Output Current | $V_{OUT} = 2.5V$ or $5V$ | 100 | | nA |
| | | $V_{OUT} = 0V$ | -100 | | nA |
| $+I_{SC}$ | Output Short Circuit Source Current | $V_{OUT} = 0V$ | -20 | | mA (min) |
| $-I_{SC}$ | Output Short Circuit Sink Current | $V_{OUT} = V_{DR}$ | 20 | | mA (min) |

POWER SUPPLY CHARACTERISTICS

| Symbol | Parameter | Conditions | Typical (Note 10) | Limits (Note 10) | Units (Limits) |
|----------|-------------------------------|--|----------------------|---------------------|-------------------|
| I_A | Analog Supply Current | PD Pin = DGND, $V_{REF} = 2.0V$ | 32.3 | 41 | mA (max) |
| | | PD Pin = V_{DR} | 8 | | mA |
| I_D | Digital Supply Current | PD Pin = DGND | 3.3 | 4.5 | mA (max) |
| | | PD Pin = V_{DR} , $f_{CLK} = 0$ | 3.5 | | mA |
| I_{DR} | Digital Output Supply Current | PD Pin = DGND, $C_L = 0 \text{ pF}$ (Note 14) | 3 | | mA (max) |
| | | PD Pin = V_{DR} , $f_{CLK} = 0$ | 0 | | mA |
| | Total Power Consumption | PD Pin = DGND, $C_L = 0 \text{ pF}$ (Note 15) | 178 | 227 | mW |
| | | PD Pin = V_{DR} , $f_{CLK} = 0$ | 40 | | mW |
| PSRR1+ | Power Supply Rejection Ratio | Rejection of Positive Full-Scale Error with $V_A = 4.75V$ to $5.25V$ | 69 | | dBFS |
| PSRR1- | Power Supply Rejection Ratio | Rejection of Positive Full-Scale Error with $V_A = 4.75V$ to $5.25V$ | 51 | | dBFS |
| PSRR2 | Power Supply Rejection Ratio | Rejection of Power Supply Noise with 10 MHz, 250 mV _{P-P} riding on V_A | 48 | | dBFS |

AC Electrical Characteristics

Unless otherwise specified, the following specifications apply for AGND = DGND = DR GND = 0V, $V_A = V_D = +5V$, $V_{DR} = +3.0V$, PD = 0V, $V_{REF} = +2.0V$, $f_{CLK} = 20$ MHz, $t_r = t_f = 3$ ns, $C_L = 25$ pF/pin. **Boldface limits apply for $T_J = T_{MIN}$ to T_{MAX} :** all other limits $T_A = T_J = 25^\circ C$ (Notes 7, 8, 9, 12)

| Symbol | Parameter | Conditions | Typical (Note 10) | Limits (Note 10) | Units (Limits) |
|------------|---|-------------------------------------|-------------------|------------------|----------------|
| f_{CLK1} | Maximum Clock Frequency | | 20 | 30 | MHz (min) |
| f_{CLK2} | Minimum Clock Frequency | | 100 | | kHz |
| t_{CH} | Clock High Time | | | 20 | ns (min) |
| t_{CL} | Clock Low Time | | | 20 | ns (min) |
| t_{CONV} | Conversion Latency | | | 6 | Clock Cycles |
| t_{OD} | Data Output Delay after Rising CLK Edge | $V_{DR} = 2.5V$ | 11 | 16.8 | ns (max) |
| | | $V_{DR} = 3.0V$ | 11 | 16.8 | ns (max) |
| t_{AD} | Aperture Delay | | 1.2 | | ns |
| t_{AJ} | Aperture Jitter | | 2 | | ps rms |
| t_{DIS} | Data outputs into TRI-STATE Mode | | 4 | | ns |
| t_{EN} | Data Outputs Active after TRI-STATE | | 4 | | ns |
| t_{PD} | Power Down Mode Exit Cycle | 0.1µF capacitors on pins 30, 31, 32 | 500 | | ns |

Note 1: Absolute Maximum Ratings indicate limits beyond which damage to the device may occur. Operating Ratings indicate conditions for which the device is functional, but do not guarantee specific performance limits. For guaranteed specifications and test conditions, see the Electrical Characteristics. The guaranteed specifications apply only for the test conditions listed. Some performance characteristics may degrade when the device is not operated under the listed test conditions.

Note 2: All voltages are measured with respect to GND = AGND = DGND = 0V, unless otherwise specified.

Note 3: When the input voltage at any pin exceeds the power supplies (that is, $V_{IN} < AGND$, or $V_{IN} > V_A$), the current at that pin should be limited to 25 mA. The 50 mA maximum package input current rating limits the number of pins that can safely exceed the power supplies with an input current of 25 mA to two.

Note 4: The absolute maximum junction temperature (T_{Jmax}) for this device is $150^\circ C$. The maximum allowable power dissipation is dictated by T_{Jmax} , the junction-to-ambient thermal resistance (θ_{JA}), and the ambient temperature, (T_A), and can be calculated using the formula $P_{DMAX} = (T_{Jmax} - T_A) / \theta_{JA}$. The values for maximum power dissipation listed above will be reached only when the device is operated in a severe fault condition (e.g. when input or output pins are driven beyond the power supply voltages, or the power supply polarity is reversed). Obviously, such conditions should always be avoided.

Note 5: Human body model is 100 pF capacitor discharged through a 1.5 kΩ resistor. Machine model is 220 pF discharged through 0Ω.

Note 6: The $235^\circ C$ reflow temperature refers to infrared reflow. For Vapor Phase Reflow (VPR), the following Conditions apply: Maintain the temperature at the top of the package body above $183^\circ C$ for a minimum 60 seconds. The temperature measured on the package body must not exceed $220^\circ C$. Only one excursion above $183^\circ C$ is allowed per reflow cycle.

Note 7: The inputs are protected as shown below. Input voltage magnitudes above V_A or below GND will not damage this device, provided current is limited per (Note 3). However, errors in the A/D conversion can occur if the input goes above V_A or below GND by more than 100 mV. As an example, if V_A is 4.75V, the full-scale input voltage must be $\leq 4.85V$ to ensure accurate conversions.

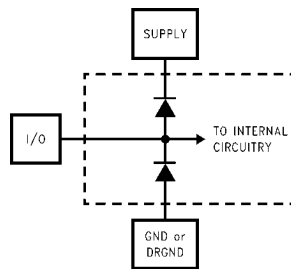

20051707

Note 8: To guarantee accuracy, it is required that $|V_A - V_D| \leq 100$ mV and separate bypass capacitors are used at each power supply pin.

Note 9: With the test condition for $V_{REF} = +2.0V$ (4V_{P-P} differential input), the 12-bit LSB is 977 µV.

Note 10: Typical figures are at $T_A = T_J = 25^\circ C$, and represent most likely parametric norms. Test limits are guaranteed to National's AOQL (Average Outgoing Quality Level).

Note 11: Integral Non Linearity is defined as the deviation of the analog value, expressed in LSBs, from the straight line that passes through positive and negative full-scale.

Note 12: Timing specifications are tested at TTL logic levels, $V_{IL} = 0.4V$ for a falling edge and $V_{IH} = 2.4V$ for a rising edge.

Note 13: Optimum performance will be obtained by keeping the reference input in the 1.8V to 2.2V range. The LM4051CIM3-ADJ (SOT-23 package) is recommended for this application.

Note 14: I_{DR} is the current consumed by the switching of the output drivers and is primarily determined by load capacitance on the output pins, the supply voltage, V_{DR} , and the rate at which the outputs are switching (which is signal dependent). $I_{DR} = V_{DR}(C_0 \times f_0 + C_1 \times f_1 + \dots + C_{11} \times f_{11})$ where V_{DR} is the output driver power supply voltage, C_n is total capacitance on the output pin, and f_n is the average frequency at which that pin is toggling.

Note 15: Excludes I_{DR} . See note 14.

Specification Definitions

APERTURE DELAY is the time after the rising edge of the clock to when the input signal is acquired or held for conversion.

APERTURE JITTER (APERTURE UNCERTAINTY) is the variation in aperture delay from sample to sample. Aperture jitter manifests itself as noise in the output.

CLOCK DUTY CYCLE is the ratio of the time during one cycle that a repetitive digital waveform is high to the total time of one period. The specification here refers to the ADC clock input signal.

COMMON MODE VOLTAGE (V_{CM}) is the d.c. potential present at both signal inputs to the ADC.

CONVERSION LATENCY See PIPELINE DELAY.

DIFFERENTIAL NON-LINEARITY (DNL) is the measure of the maximum deviation from the ideal step size of 1 LSB.

EFFECTIVE NUMBER OF BITS (ENOB, or EFFECTIVE BITS) is another method of specifying Signal-to-Noise and Distortion or SINAD. ENOB is defined as $(\text{SINAD} - 1.76) / 6.02$ and says that the converter is equivalent to a perfect ADC of this (ENOB) number of bits.

FULL POWER BANDWIDTH is a measure of the frequency at which the reconstructed output fundamental drops 3 dB below its low frequency value for a full scale input.

Gain Error = Pos. Full Scale Error – Neg. Full Scale Error

GAIN ERROR is the deviation from the ideal slope of the transfer function. It is the difference between the input that cause a transition from all zeros to the first code.

INTEGRAL NON LINEARITY (INL) is a measure of the deviation of each individual code from a line drawn from negative full scale ($\frac{1}{2}$ LSB below the first code transition) through positive full scale ($\frac{1}{2}$ LSB above the last code transition). The deviation of any given code from this straight line is measured from the center of that code value.

INTERMODULATION DISTORTION (IMD) is the creation of additional spectral components as a result of two sinusoidal frequencies being applied to the ADC input at the same time. It is defined as the ratio of the power in the intermodulation products to the total power in the original frequencies. IMD is usually expressed in dBFS.

MISSING CODES are those output codes that will never appear at the ADC outputs. The ADC12020 is guaranteed not to have any missing codes.

NEGATIVE FULL SCALE ERROR is the difference between the actual first code transition and its ideal value of $\frac{1}{2}$ LSB above negative full scale.

OFFSET ERROR is the difference between the two input voltages ($V_{IN+} - V_{IN-}$) required to cause a transition from code 2047 to 2048.

OUTPUT DELAY is the time delay after the rising edge of the clock before the data update is presented at the output pins.

PIPELINE DELAY (LATENCY) is the number of clock cycles between initiation of conversion and when that data is presented to the output driver stage. Data for any given sample is available at the output pins the Pipeline Delay plus the Output Delay after the sample is taken. New data is available at every clock cycle, but the data lags the conversion by the pipeline delay.

POSITIVE FULL SCALE ERROR is the difference between the actual last code transition and its ideal value of $1\frac{1}{2}$ LSB below positive full scale.

POWER SUPPLY REJECTION RATIO (PSRR) is a measure of how well the ADC rejects a change in the power supply voltage. For the ADC12020, PSRR1 is the ratio of the change in Full-Scale Error that results from a change in the dc power supply voltage, expressed in dB. PSRR2 is a measure of how well an a.c. signal riding upon the power supply is rejected at the output.

SIGNAL TO NOISE RATIO (SNR) is the ratio, expressed in dB, of the rms value of the input signal to the rms value of the sum of all other spectral components below one-half the sampling frequency, not including harmonics or dc.

SIGNAL TO NOISE PLUS DISTORTION (S/N+D or SINAD) is the ratio, expressed in dB, of the rms value of the input signal to the rms value of all of the other spectral components below half the clock frequency, including harmonics but excluding dc.

SPURIOUS FREE DYNAMIC RANGE (SFDR) is the difference, expressed in dB, between the desired signal amplitude to the amplitude of the peak spurious spectral component, where a spurious spectral component is any signal present in the output spectrum that is not present at the input and may or may not be a harmonic.

TOTAL HARMONIC DISTORTION (THD) is the ratio, expressed in dBc, of the rms total of the first nine harmonic levels at the output to the level of the fundamental at the output. THD is calculated as

$$\text{THD} = 20 \times \log \sqrt{\frac{f_2^2 + \dots + f_{10}^2}{f_1^2}}$$

where f_1 is the RMS power of the fundamental (output) frequency and f_2 through f_{10} are the RMS power in the first 9 harmonic frequencies.

Timing Diagram

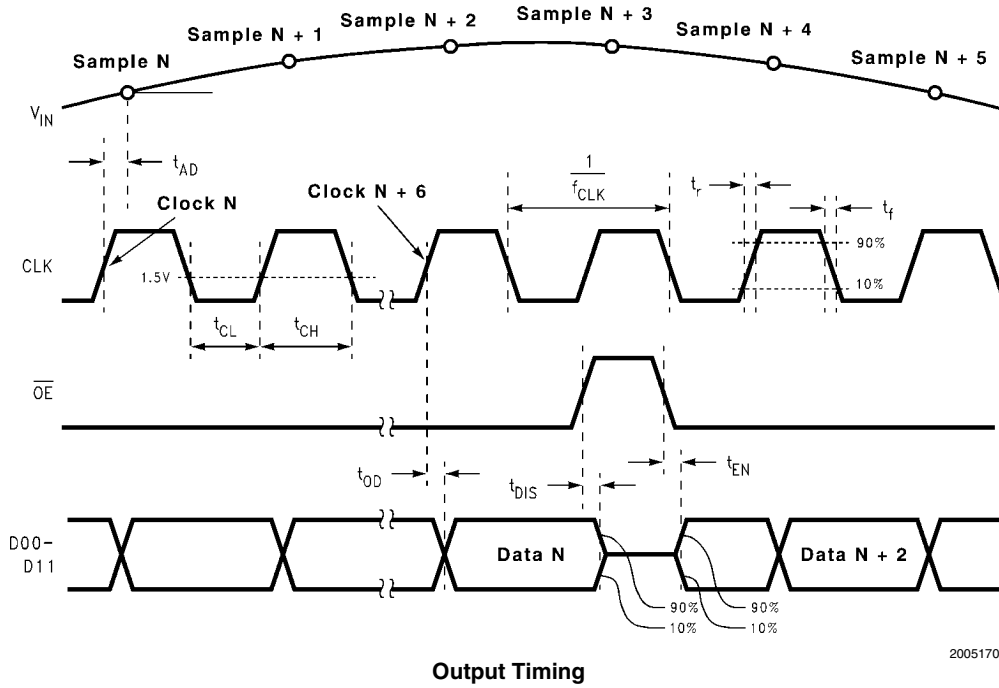

20051709

Output Timing

Transfer Characteristic

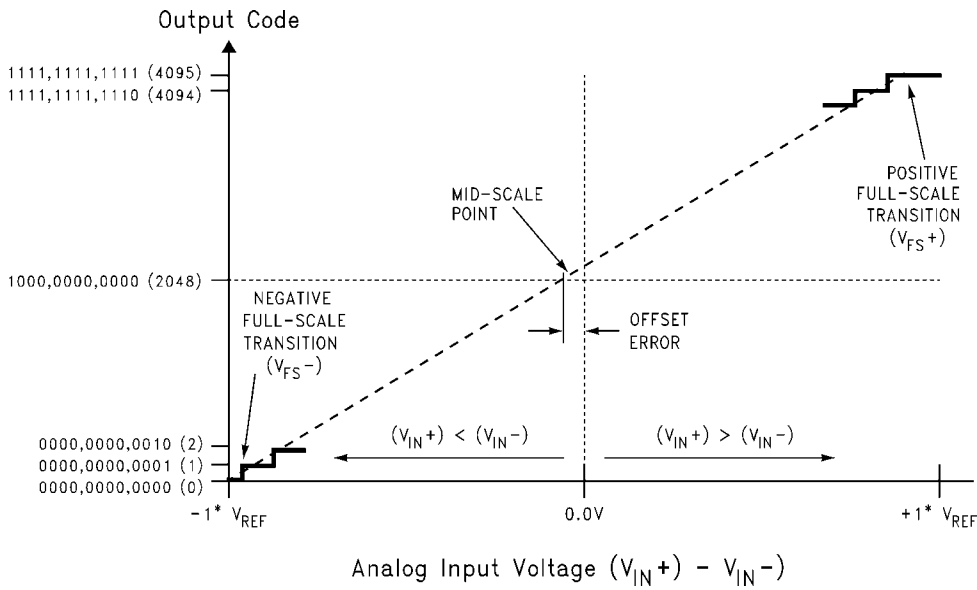

20051710

FIGURE 1. Transfer Characteristic

ADC12020 Typical Performance Characteristics $V_A = V_D = 5V$, $V_{DR} = 3.0V$, $f_{CLK} = 20\text{ MHz}$,
 $f_{IN} = 10.1\text{ MHz}$, $V_{REF} = 2.0V$ unless otherwise stated

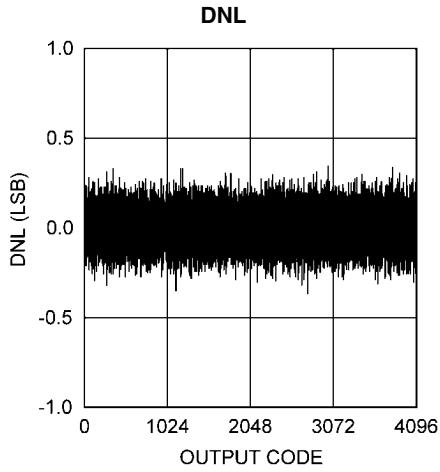

20051718

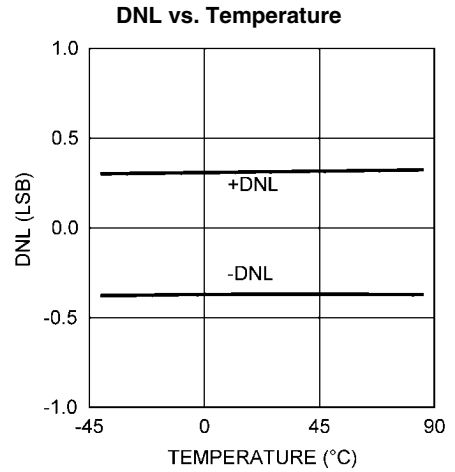

20051719

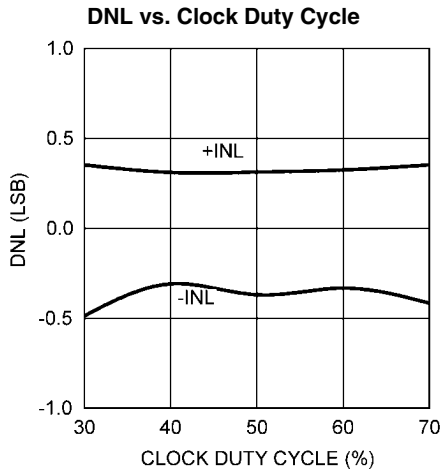

20051720

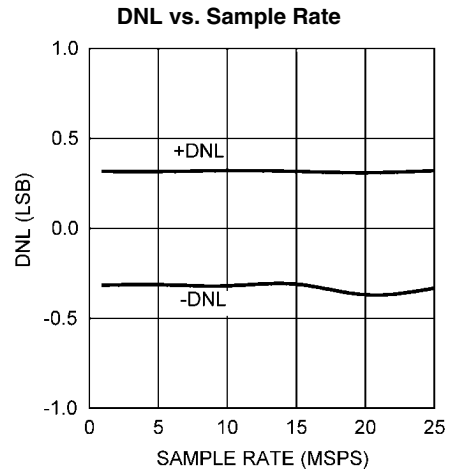

20051721

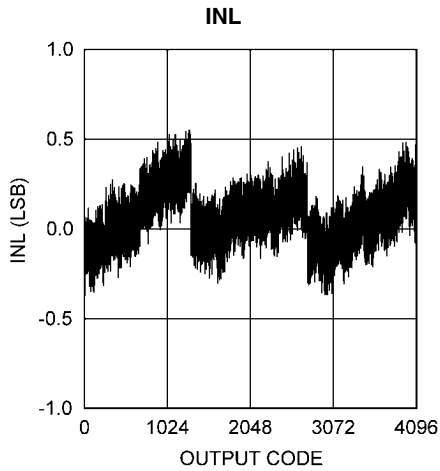

20051722

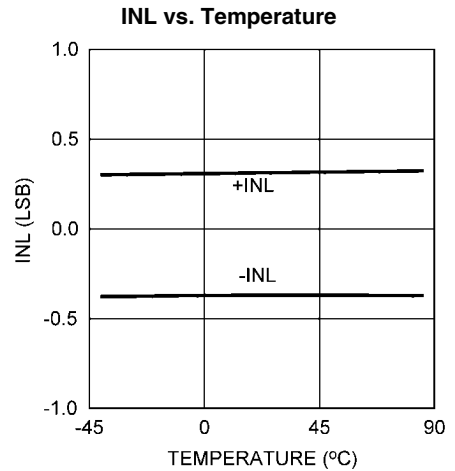

20051723

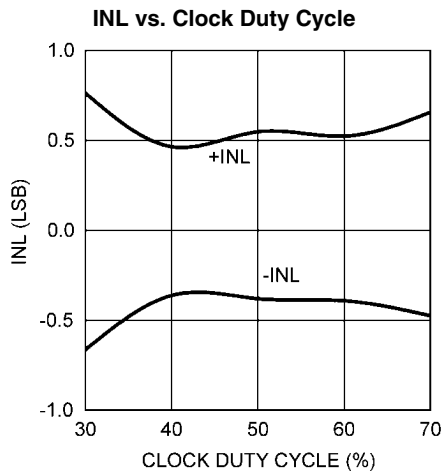

20051724

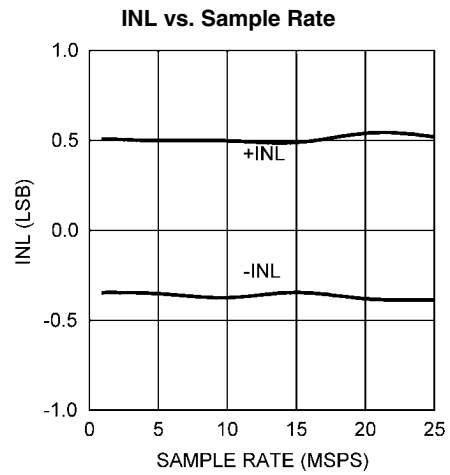

20051725

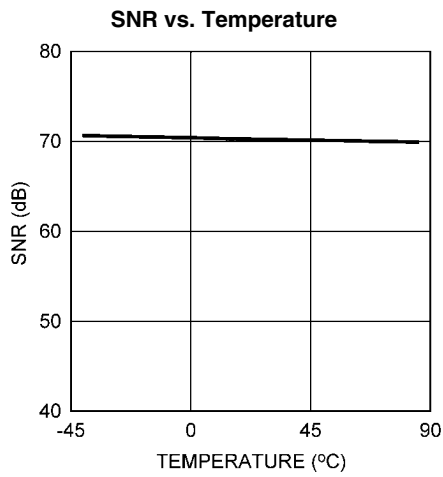

20051726

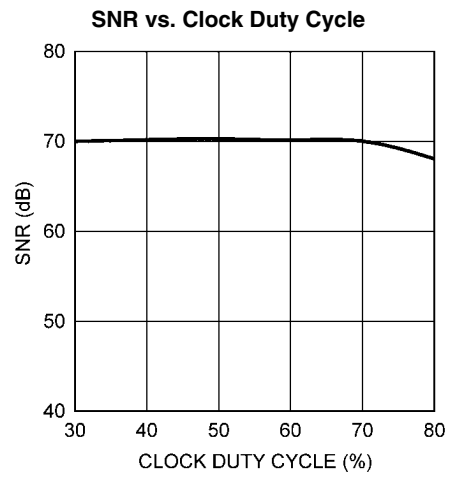

20051731

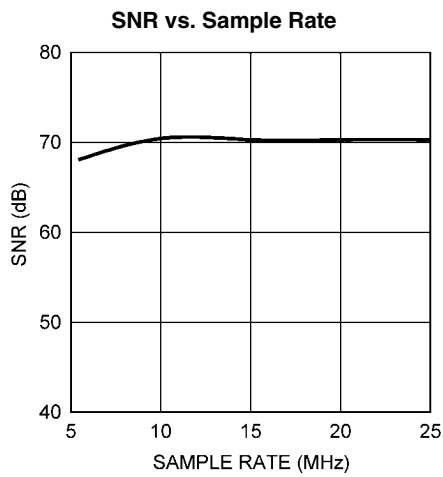

20051732

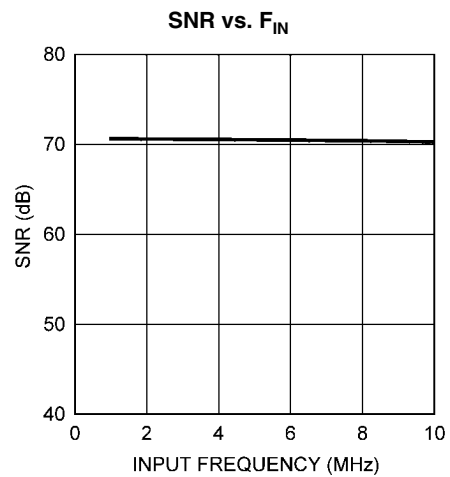

20051733

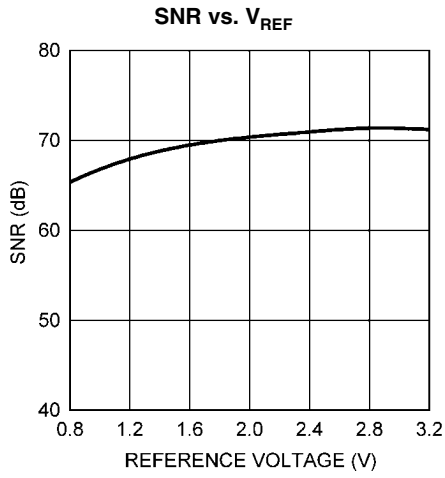

20051735

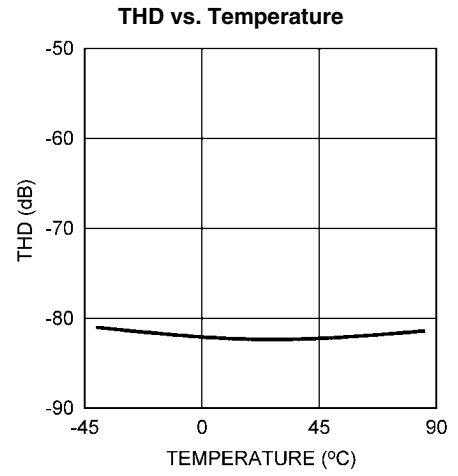

20051736

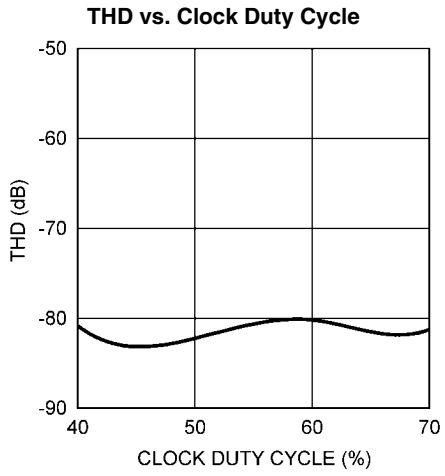

20051737

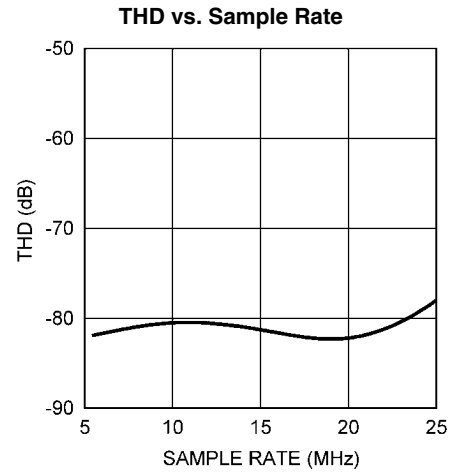

20051738

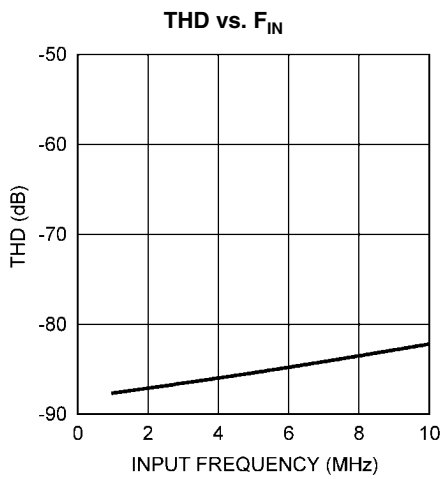

20051739

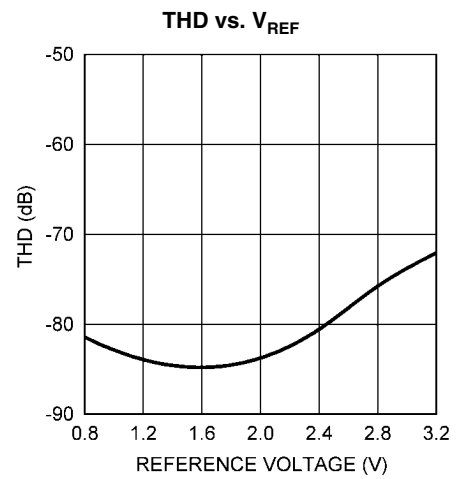

20051740

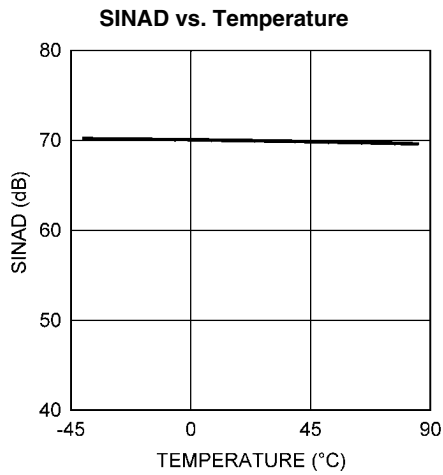

20051741

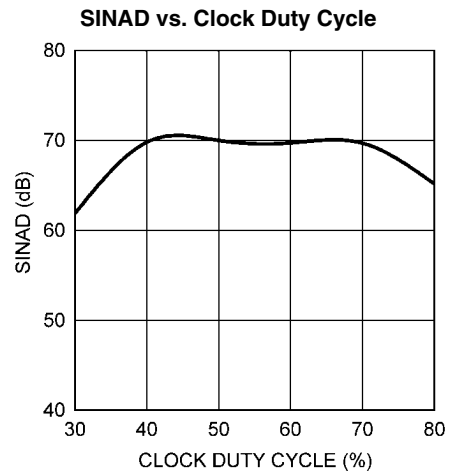

20051742

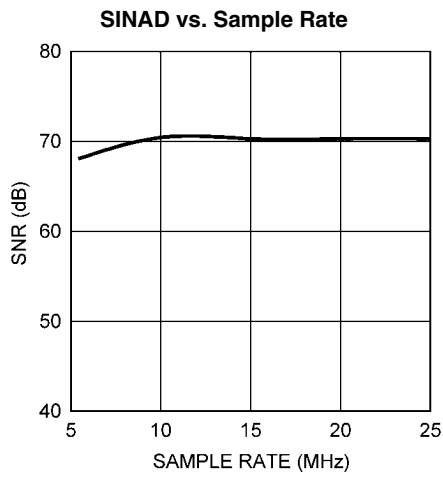

20051743

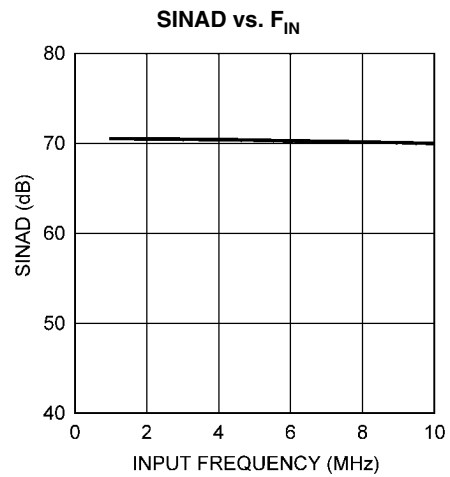

20051744

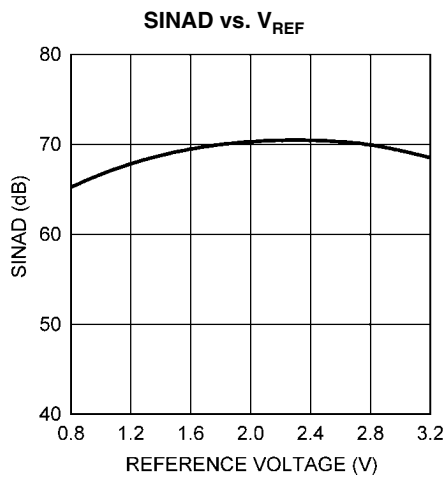

20051745

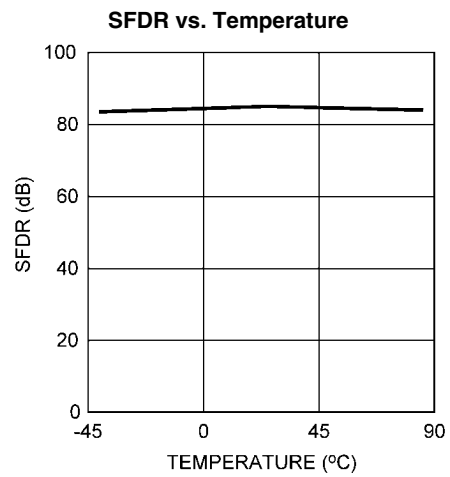

20051746

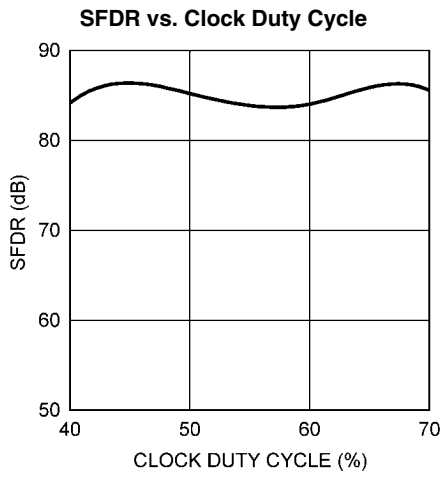

20051747

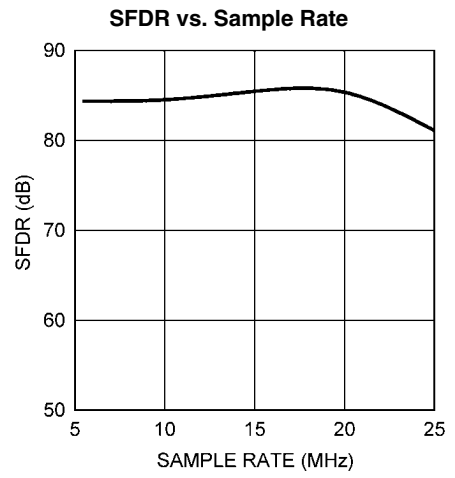

20051748

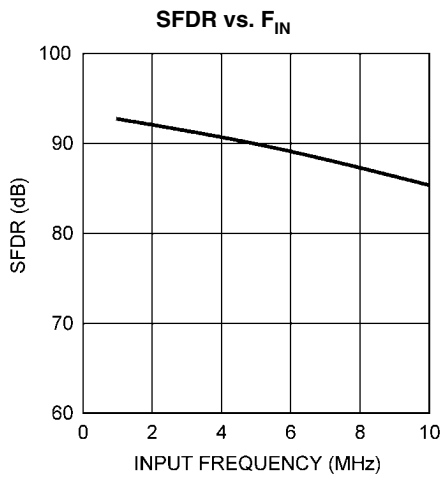

20051749

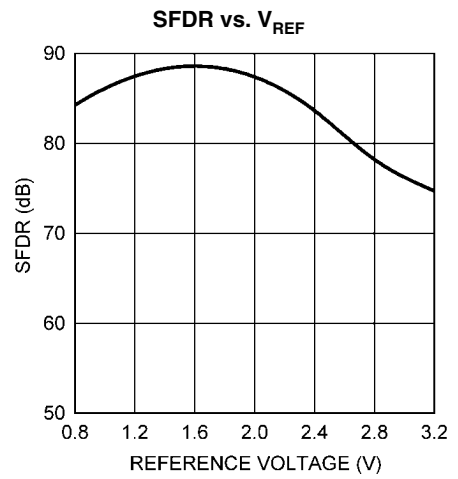

20051750

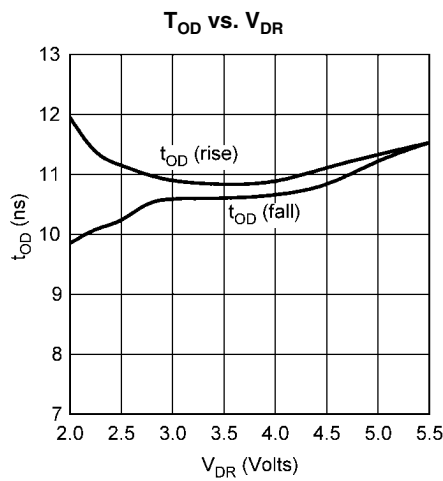

20051751

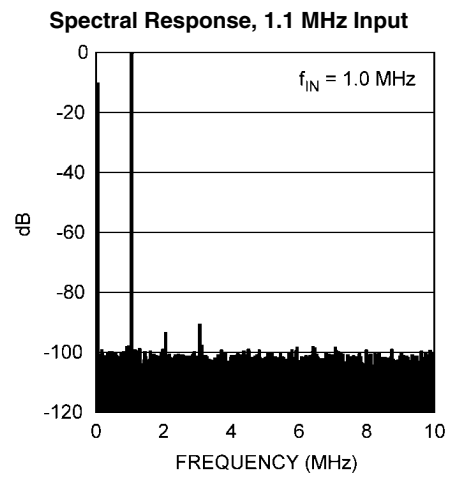

20051752

Spectral Response, 44 MHz Input

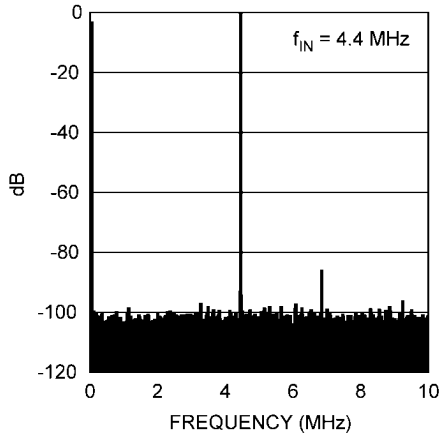

Spectral Response, 10.1 MHz Input

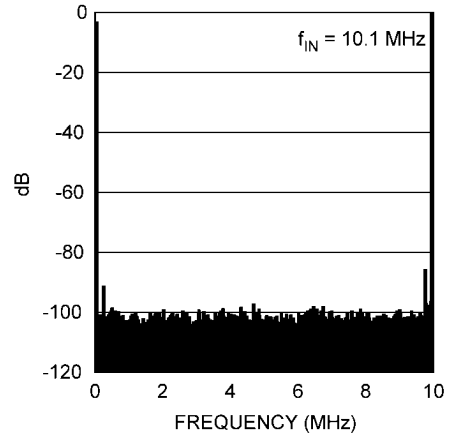

Spectral Response

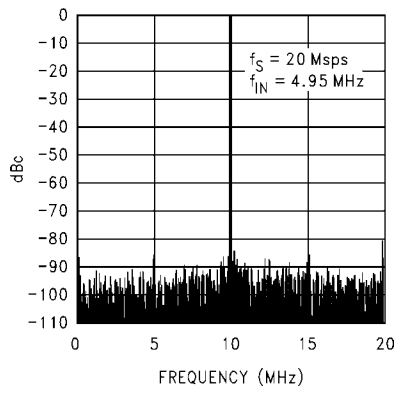

IMD @ F₁ = 9.5MHz, F₂ = 10.5MHz

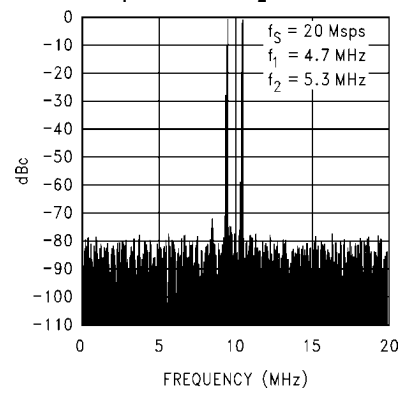

Functional Description

Operating on a single +5V supply, the ADC12020 uses a pipeline architecture and has error correction circuitry to help ensure maximum performance. The differential analog input signal is digitized to 12 bits.

The reference input is buffered to ease the task of driving that pin. The output word rate is the same as the clock frequency. The analog input voltage is acquired at the rising edge of the clock and the digital data for a given sample is delayed by the pipeline for 6 clock cycles.

A logic high on the power down (PD) pin reduces the converter power consumption to 40 mW.

Applications Information

1.0 OPERATING CONDITIONS

We recommend that the following conditions be observed for operation of the ADC12020:

$$4.75V \leq V_A \leq 5.25V$$

$$V_D = V_A$$

$$2.35V \leq V_{DR} \leq V_D$$

$$100 \text{ kHz} \leq f_{CLK} \leq 30 \text{ MHz}$$

$$1.0V \leq V_{REF} \leq 2.4V$$

$$1.0V \leq V_{CM} \leq 4.0V$$

1.1 Analog Inputs

The ADC12020 has two analog signal inputs, V_{IN+} and V_{IN-} . These two pins form a differential input pair. There is one reference input pin, V_{REF} .

1.2 Reference Pins

The ADC12020 is designed to operate with a 2.0V reference, but performs well with reference voltages in the range of 1.0V to 2.4V. Lower reference voltages will decrease the signal-to-noise ratio (SNR). Increasing the reference voltage (and the input signal swing) beyond 2.4V will degrade THD for a full-scale input.

It is very important that all grounds associated with the reference voltage and the input signal make connection to the ground plane at a single point to minimize the effects of noise currents in the ground path.

The three Reference Bypass Pins (V_{RP} , V_{RM} and V_{RN}) are made available for bypass purposes. These pins should each be bypassed to ground with a 0.1 μ F capacitor. Smaller capacitor values will allow faster recovery from the power down mode, but may result in degraded noise performance. DO NOT LOAD these pins.

1.3 Signal Inputs

The signal inputs are V_{IN+} and V_{IN-} . The input signal, V_{IN} , is defined as

$$V_{IN} = (V_{IN+}) - (V_{IN-})$$

Figure 2 shows the expected input signal range.

Note that the common mode input voltage range is 1V to 3V with a nominal value of $V_A/2$. The input signals should remain between ground and 4V.

The Peaks of the individual input signals (V_{IN+} and V_{IN-}) should each never exceed the voltage described as

$$V_{IN+}, V_{IN-} = V_{REF} + V_{CM}$$

to maintain THD and SINAD performance.

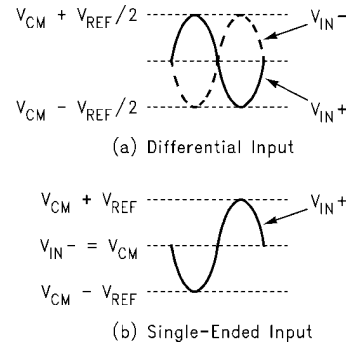

20051711

FIGURE 2. Expected Input Signal Range

The ADC12020 performs best with a differential input with each input centered around V_{CM} . The peak-to-peak voltage swing at both V_{IN+} and V_{IN-} each should not exceed the value of the reference voltage or the output data will be clipped. The two input signals should be exactly 180° out of phase from each other and of the same amplitude. For single frequency inputs, angular errors result in a reduction of the effective full scale input. For a complex waveform, however, angular errors will result in distortion.

For angular deviations of up to 10 degrees from these two signals being 180 out of phase, the full scale error in LSB can be described as approximately

$$E_{FS} = 4096 (1 - \sin(90^\circ + dev))$$

Where dev is the angular difference, in degrees, between the two signals having a 180° relative phase relationship to each other (see Figure 3). Drive the analog inputs with a source impedance less than 100 Ω .

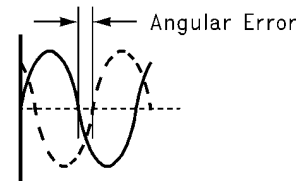

20051712

FIGURE 3. Angular Errors Between the Two Input Signals Will Reduce the Output Level

For differential operation, each analog input signal should have a peak-to-peak voltage equal to the input reference voltage, V_{REF} , and be centered around a common mode voltage, V_{CM} .

TABLE 1. Input to Output Relationship—Differential Input

| V_{IN+} | V_{IN-} | Output |
|----------------------|----------------------|----------------|
| $V_{CM} - V_{REF}/2$ | $V_{CM} + V_{REF}/2$ | 0000 0000 0000 |
| $V_{CM} - V_{REF}/4$ | $V_{CM} + V_{REF}/4$ | 0100 0000 0000 |
| V_{CM} | V_{CM} | 1000 0000 0000 |
| $V_{CM} + V_{REF}/4$ | $V_{CM} - V_{REF}/4$ | 1100 0000 0000 |
| $V_{CM} + V_{REF}/2$ | $V_{CM} - V_{REF}/2$ | 1111 1111 1111 |

TABLE 2. Input to Output Relationship—Single-Ended Input

| V_{IN+} | V_{IN-} | Output |
|----------------------|-----------|----------------|
| $V_{CM} - V_{REF}$ | V_{CM} | 0000 0000 0000 |
| $V_{CM} - V_{REF}/2$ | V_{CM} | 0100 0000 0000 |
| V_{CM} | V_{CM} | 1000 0000 0000 |
| $V_{CM} + V_{REF}/2$ | V_{CM} | 1100 0000 0000 |
| $V_{CM} + V_{REF}$ | V_{CM} | 1111 1111 1111 |

1.3.1 Single-Ended Operation

Single-ended performance is lower than with differential input signals. For this reason, single-ended operation is not recommended. However, if single ended-operation is required, and the resulting performance degradation is acceptable, one of the analog inputs should be connected to the d.c. common mode voltage of the driven input. The peak-to-peak differential input signal should be twice the reference voltage to maximize SNR and SINAD performance (*Figure 2b*). For example, set V_{REF} to 1.0V, bias V_{IN-} to 1.0V and drive V_{IN+} with a signal range of 0V to 2.0V.

Because very large input signal swings can degrade distortion performance, better performance with a single-ended input can be obtained by reducing the reference voltage when maintaining a full-range output. and indicate the input to output relationship of the ADC12020.

1.3.2 Driving the Analog Inputs

The V_{IN+} and the V_{IN-} inputs of the ADC12020 consist of an analog switch followed by a switched-capacitor amplifier. The capacitance seen at the analog input pins changes with the clock level, appearing as 8 pF when the clock is low, and 7 pF when the clock is high. Although this difference is small, a dynamic capacitance is more difficult to drive than is a fixed capacitance, so choose the driving amplifier carefully. The LMH6550, the LMH6702 and the LM6628 are good amplifiers for driving the ADC12020.

The internal switching action at the analog inputs causes energy to be output from the input pins. As the driving source tries to compensate for this, it adds noise to the signal. To prevent this, use an RC at each of the inputs, as shown in *Figure 5* and *Figure 6*. These components should be placed close to the ADC because the input pins of the ADC is the most sensitive part of the system and this is the last opportunity to filter the input. For undersampling applications, the capacitors should be eliminated.

The LMH6550 and the LMH6552 are excellent devices for driving the ADC12020, especially when single-ended to differential conversion with d.c. coupling is necessary. An example of the use of the LMH6550 to drive the analog input of the ADC12020 is shown in *Figure 5*.

For high frequency, narrow band applications, a transformer is generally the recommended way to drive the analog inputs, as shown in *Figure 6*.

1.3.3 Input Common Mode Voltage

The input common mode voltage, V_{CM} , should be in the range of 0.5V to 4.0V and be of a value such that the peak excursions of the analog signal does not go more negative than ground or more positive than 1.2 Volts below the V_A supply voltage. The nominal V_{CM} should generally be equal to $V_{REF}/2$, but V_{RM} can be used as a V_{CM} source as long as V_{CM} need not supply more than 10 μ A of current. *Figure 5* shows the use of the V_{RM} output to drive the V_{CM} input of the

LMH6550. The common mode output voltage of the LMH6550 is equal to the V_{CM} input input voltage.

2.0 DIGITAL INPUTS

The digital TTL/CMOS compatible inputs consist of CLK, \overline{OE} and PD.

2.1 CLK

The **CLK** signal controls the timing of the sampling process. Drive the clock input with a stable, low jitter clock signal in the range of 100 kHz to 30 MHz with rise and fall times of less than 3ns. The trace carrying the clock signal should be as short as possible and should not cross any other signal line, analog or digital, not even at 90°.

If the **CLK** is interrupted, or its frequency too low, the charge on internal capacitors can dissipate to the point where the accuracy of the output data will degrade. This is what limits the lowest sample rate to 100 ksp/s.

The duty cycle of the clock signal can affect the performance of the A/D Converter. Because achieving a precise duty cycle is difficult, the ADC12020 is designed to maintain performance over a range of duty cycles. While it is specified and performance is guaranteed with a 50% clock duty cycle, performance is typically maintained over a clock duty cycle range of 40% to 60%.

The clock line should be terminated at its source in the characteristic impedance of that line. It is highly desirable that the the source driving the ADC **CLK** pin only drive that pin. However, if that source is used to drive other things, each driven pin should be a.c. terminated with a series RC to ground, as shown in *Figure 4*, such that the resistor value is equal to the characteristic impedance of the clock line and the capacitor value is

$$C \geq \frac{4 \times t_{PD} \times L}{Z_0}$$

where t_{PR} is the signal propagation rate down the clock line, "L" is the line length and Z_0 is the characteristic impedance of the clock line. This termination should be as close as possible to the ADC clock pin but beyond it as seen from the clock source. Typical t_{PD} is about 150 ps/inch (60 ps/cm) on FR-4 board material. The units of "L" and t_{PD} should be the same (inches or centimeters).

Take care to maintain a constant clock line impedance throughout the length of the line. Refer to Application Note AN-905 or AN-1113 for information on setting and determining characteristic impedance.

2.2 \overline{OE}

The \overline{OE} pin, when high, puts the output pins into a high impedance state. When this pin is low the outputs are in the active state. The ADC12020 will continue to convert whether this pin is high or low, but the output can not be read while the \overline{OE} pin is high.

The \overline{OE} pin should NOT be used to multiplex devices together to drive a common bus as this will result in excessive capacitance on the data output pins, reducing SNR and SINAD performance of the converter. See Section 3.0.

2.3 PD

The PD pin, when high, holds the ADC12020 in a power-down mode to conserve power when the converter is not being used. The power consumption in this state is 40 mW with a 20 MHz clock and the output data pins are undefined in this

mode. The data in the pipeline is corrupted while in the power down mode.

The Power Down Mode Exit Cycle time is determined by the value of the capacitors on pins 30, 31 and 32. These capacitors lose their charge in the Power Down mode and must be charged by on-chip circuitry before conversions can be accurate.

3.0 DATA OUTPUTS

The ADC12020 has 12 TTL/CMOS compatible Data Output pins. Valid offset binary data is present at these outputs while the \overline{OE} and PD pins are low. While the t_{OD} time provides information about output timing, a simple way to capture a valid output is to latch the data on the falling edge of the conversion clock (pin 10).

Be very careful when driving a high capacitance bus. The more capacitance the output drivers must charge for each conversion, the more instantaneous digital current flows through V_{DR} and DR GND. These large charging current

spikes can cause on-chip noise that can couple into the analog circuitry, degrading dynamic performance. Adequate power supply bypassing and careful attention to the ground plane will reduce this problem. Additionally, bus capacitance beyond that specified will cause t_{OD} to increase, making it difficult to properly latch the ADC output data. The result could be an apparent reduction in dynamic performance.

To minimize noise due to output switching, minimize the load currents at the digital outputs. This can be done by connecting buffers (74AC541, for example) between the ADC outputs and any other circuitry. Only one driven input should be connected to each output pin. Additionally, inserting series resistors of 100Ω at the digital outputs, close to the ADC pins, will isolate the outputs from trace and other circuit capacitances and limit the output currents, which could otherwise result in performance degradation. See Figure 4.

While the ADC12020 will operate with V_{DR} voltages down to 1.8V, t_{OD} increases with reduced V_{DR} . Be careful of external timing when using reduced V_{DR} .

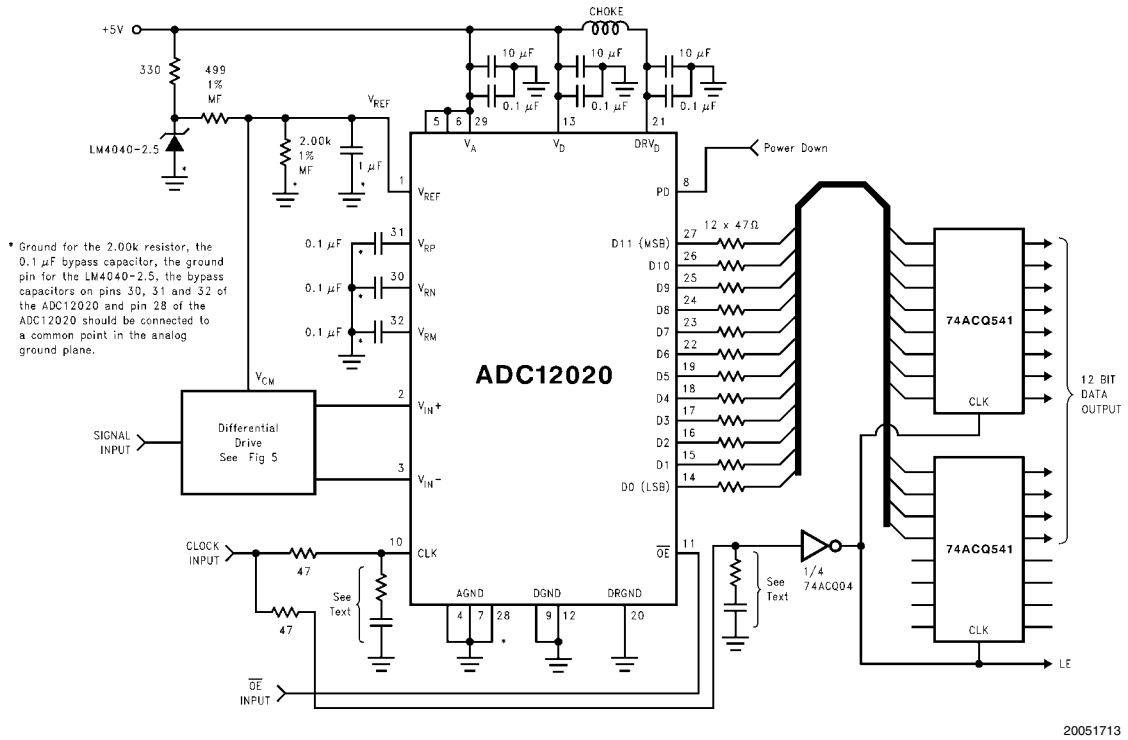

FIGURE 4. Simple Application Circuit with Single-Ended to Differential Buffer

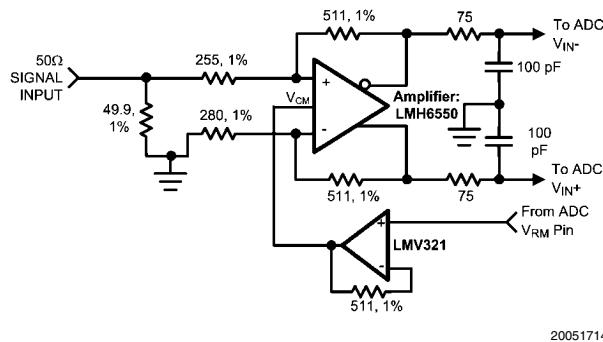

FIGURE 5. Differential Drive Circuit of Figure 4

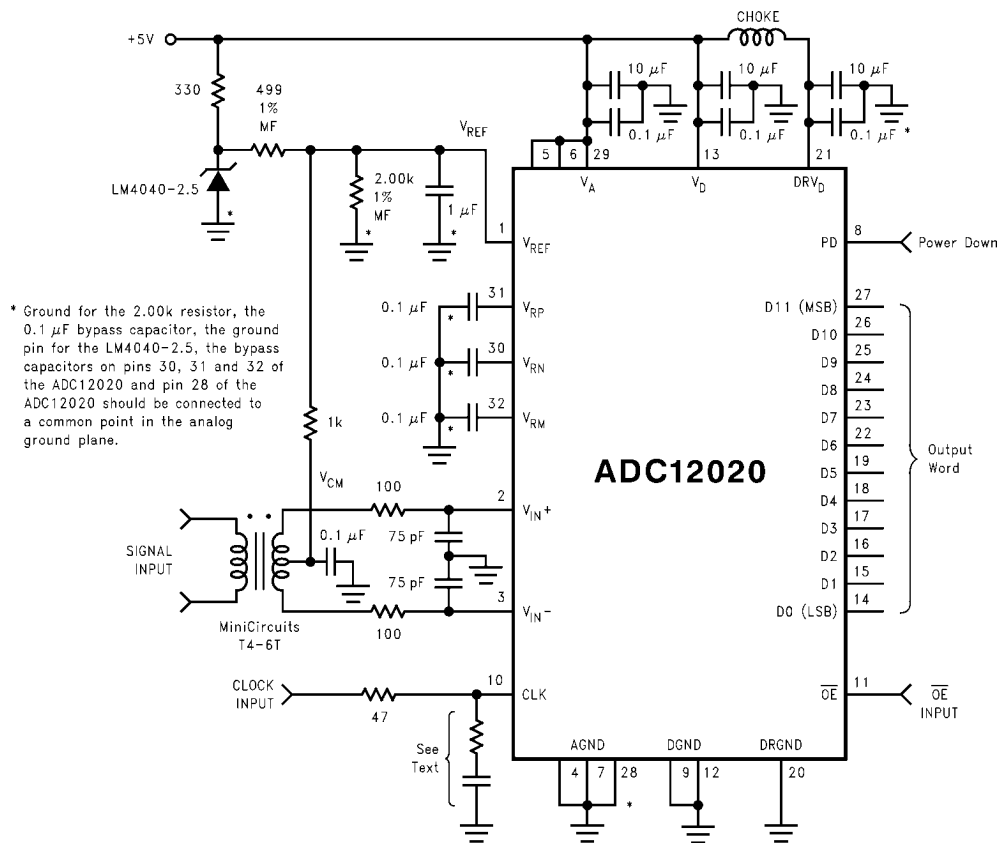

FIGURE 6. Driving the Signal Inputs with a Transformer

4.0 POWER SUPPLY CONSIDERATIONS

The power supply pins should be bypassed with a 10 μF capacitor and with a 0.1 μF ceramic chip capacitor within a centimeter of each power pin. Leadless chip capacitors are preferred because they have low series inductance.

As is the case with all high-speed converters, the ADC12020 is sensitive to power supply noise. Accordingly, the noise on the analog supply pin should be kept below 100 mV_{P-P}.

No pin should ever have a voltage on it that is in excess of the supply voltages, not even on a transient basis. Be especially careful of this during turn on and turn off of power.

The V_{DR} pin provides power for the output drivers and may be operated from a supply in the range of 2.35V to V_D (nominal 5V). This can simplify interfacing to 3V devices and systems.

DO NOT operate the V_{DR} pin at a voltage higher than V_D.

5.0 LAYOUT AND GROUNDING

Proper grounding and proper routing of all signals are essential to ensure accurate conversion. Maintaining separate analog and digital areas of the board, with the ADC12020 between these areas, is required to achieve specified performance.

The ground return for the data outputs (DR GND) carries the ground current for the output drivers. The output current can exhibit high transients that could add noise to the conversion process. To prevent this from happening, the DR GND pins should NOT be connected to system ground in close proximity to any of the ADC12020's other ground pins.

Capacitive coupling between the typically noisy digital circuitry and the sensitive analog circuitry can lead to poor performance. The solution is to keep the analog circuitry separated from the digital circuitry, and to keep the clock line as short as possible.

Digital circuits create substantial supply and ground current transients. The logic noise thus generated could have significant impact upon system noise performance. The best logic family to use in systems with A/D converters is one which employs non-saturating transistor designs, or has low noise characteristics, such as the 74LS, 74HC(T) and 74AC(T)Q families. The worst noise generators are logic families that draw the largest supply current transients during clock or signal edges, like the 74F and the 74AC(T) families. In high speed circuits, however, it is often necessary to use these higher speed devices. Best performance requires careful attention to PC board layout and to proper signal integrity techniques.

The effects of the noise generated from the ADC output switching can be minimized through the use of 47Ω to 100Ω resistors in series with each data output line. Locate these resistors as close to the ADC output pins as possible.

Since digital switching transients are composed largely of high frequency components, total ground plane copper weight will have little effect upon the logic-generated noise. This is because of the skin effect. Total surface area is more important than is total ground plane volume.

Generally, analog and digital lines should cross each other at 90° to avoid crosstalk. To maximize accuracy in high speed,

20051715

high resolution systems, however, avoid crossing analog and digital lines altogether. It is important to keep clock lines as short as possible and isolated from ALL other lines, including other digital lines. Even the generally accepted 90° crossing should be avoided with the clock line as even a little coupling can cause problems at high frequencies. This is because other lines can introduce jitter into the clock line, which can lead

to degradation of SNR. Also, the high speed clock can introduce noise into the analog chain. Best performance at high frequencies and at high resolution is obtained with a straight signal path. That is, the signal path through all components should form a straight line wherever possible.

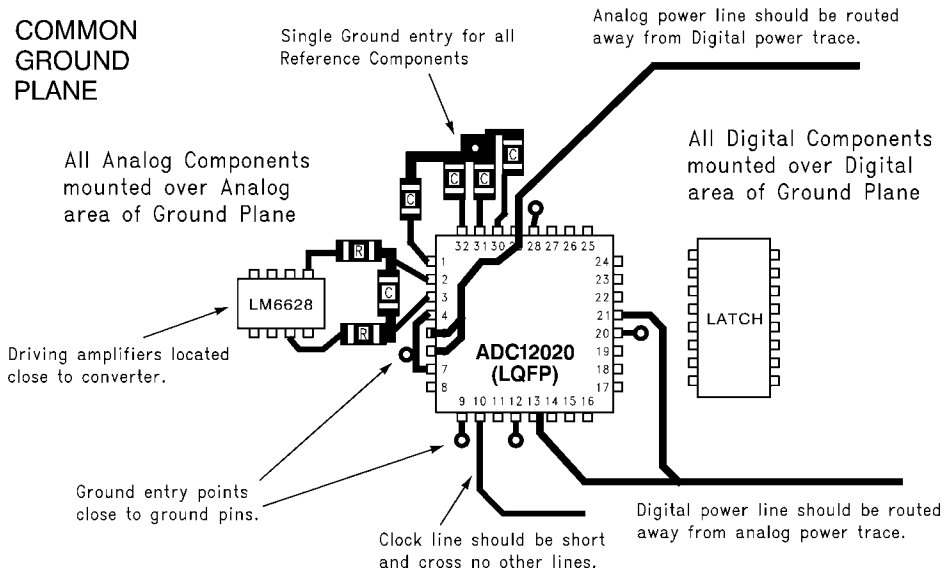

FIGURE 7. Example of a Suitable Layout

Be especially careful with the layout of inductors. Mutual inductance can change the characteristics of the circuit in which they are used. Inductors should *not* be placed side by side, even with just a small part of their bodies beside each other. The analog input should be isolated from noisy signal traces to avoid coupling of spurious signals into the input. Any external component (e.g., a filter capacitor) connected between the converter's input pins and ground or to the reference input pin and ground should be connected to a very clean point in the analog ground plane.

Figure 7 gives an example of a suitable layout. A single ground plane is recommended with separate analog and digital power planes. The analog and digital power planes should NOT overlap each other. All analog circuitry (input amplifiers, filters, reference components, etc.) should be placed over the analog power plane. All digital circuitry and I/O lines should be placed over the digital power plane. Furthermore, all components in the reference circuitry and the input signal chain that are connected to ground should be connected together with short traces and enter the ground plane at a single point. All ground connections should have a low inductance path to ground.

6.0 DYNAMIC PERFORMANCE

To achieve the best dynamic performance, the clock source driving the CLK input must be free of jitter. Isolate the ADC clock from any digital circuitry with buffers, as with the clock tree shown in Figure 8.

As mentioned in Section 5.0, it is good practice to keep the ADC clock line as short as possible and to keep it well away from any other signals. Other signals can introduce jitter into the clock signal, which can lead to reduced SNR performance, and the clock can introduce noise into other lines.

Even lines with 90° crossings have capacitive coupling, so try to avoid even these 90° crossings of the clock line.

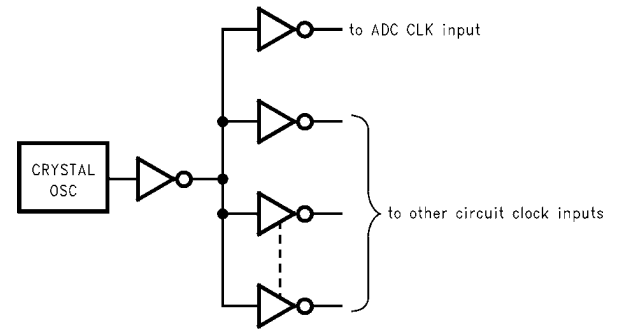

FIGURE 8. Isolating the ADC Clock from other Circuitry with a Clock Tree

7.0 COMMON APPLICATION PITFALLS

Driving the inputs (analog or digital) beyond the power supply rails. For proper operation, all inputs should not go more than 100 mV beyond the supply rails (more than 100 mV below the ground pins or 100 mV above the supply pins). Exceeding these limits on even a transient basis may cause faulty or erratic operation. It is not uncommon for high speed digital components (e.g., 74F and 74AC devices) to exhibit overshoot or undershoot that goes above the power supply or below ground. A resistor of about 50Ω to 100Ω in series with any offending digital input, close to the signal source, will eliminate the problem.

Do not allow input voltages to exceed the supply voltage, even on a transient basis. Not even during power up or power down.

Be careful not to overdrive the inputs of the ADC12020 with a device that is powered from supplies outside the range of the ADC12020 supply. Such practice may lead to conversion inaccuracies and even to device damage.

Attempting to drive a high capacitance digital data bus.

The more capacitance the output drivers must charge for each conversion, the more instantaneous digital current flows through V_{DR} and DR GND. These large charging current spikes can couple into the analog circuitry, degrading dynamic performance. Adequate bypassing and maintaining separate analog and digital areas on the pc board will reduce this problem.

Additionally, bus capacitance beyond that specified will cause t_{OD} to increase, making it difficult to properly latch the ADC output data. The result could, again, be an apparent reduction in dynamic performance.

The digital data outputs should be buffered (with 74ACQ541, for example). Dynamic performance can also be improved by adding series resistors at each digital output, close to the ADC12020, which reduces the energy coupled back into the converter output pins by limiting the output current. A reasonable value for these resistors is 100Ω .

Using an inadequate amplifier to drive the analog input.

As explained in Section 1.3, the capacitance seen at the input alternates between 8 pF and 7 pF, depending upon the phase of the clock. This dynamic load is more difficult to drive than is a fixed capacitance.

If the amplifier exhibits overshoot, ringing, or any evidence of instability, even at a very low level, it will degrade performance. A small series resistor and shunt capacitor at each amplifier output (as shown in *Figure 5* and *Figure 6*) will improve performance. The LMH6550, the LMH6702 and the LMH6628 have been successfully used to drive the analog inputs of the ADC12020.

Also, it is important that the signals at the two inputs have exactly the same amplitude and be exactly 180° out of phase with each other. Board layout, especially equality of the length of the two traces to the input pins, will affect the effective phase between these two signals. Remember that an operational amplifier operated in the non-inverting configuration will exhibit more time delay than will the same device operating in the inverting configuration.

Operating with the reference pins outside of the specified range. As mentioned in Section 1.2, V_{REF} should be in the range of

$$1.0V \leq V_{REF} \leq 2.4V$$

Operating outside of these limits could lead to performance degradation.

Using a clock source with excessive jitter, using excessively long clock signal trace, or having other signals coupled to the clock signal trace. This will cause the sampling interval to vary, causing excessive output noise and a reduction in SNR and SINAD performance.

Physical Dimensions inches (millimeters) unless otherwise noted

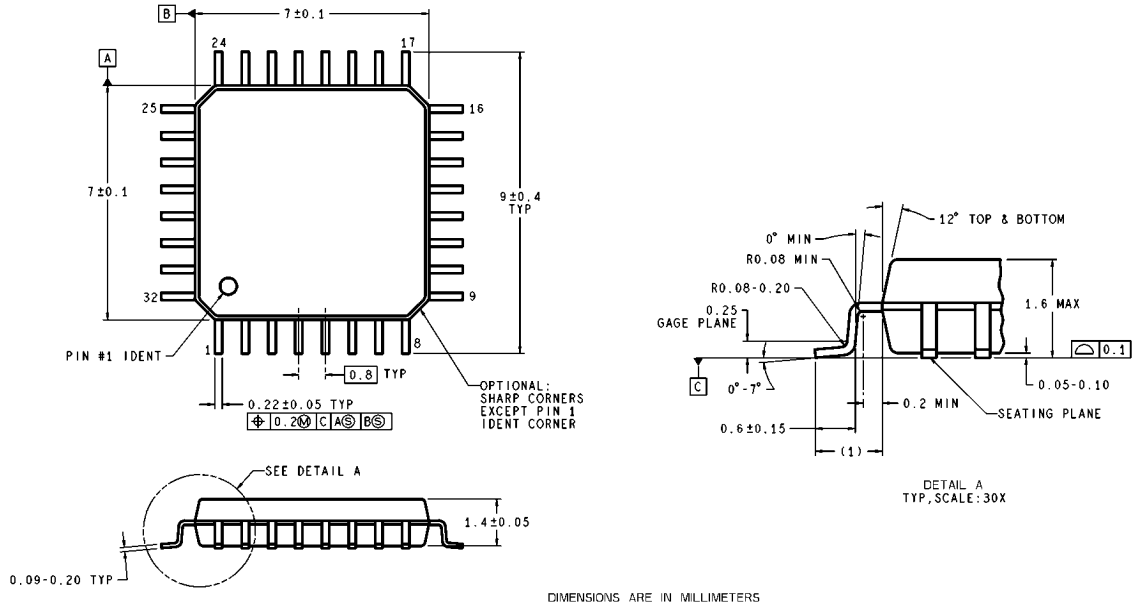

DIMENSIONS ARE IN MILLIMETERS

VBE32A (Rev E)

32-Lead LQFP Package
Ordering Number ADC12020CIVY
NS Package Number VBE32A

Notes

Notes

For more National Semiconductor product information and proven design tools, visit the following Web sites at:

| Products | | Design Support | |
|--------------------------------|--|-------------------------|--|
| Amplifiers | www.national.com/amplifiers | WEBENCH | www.national.com/webench |
| Audio | www.national.com/audio | Analog University | www.national.com/AU |
| Clock Conditioners | www.national.com/timing | App Notes | www.national.com/appnotes |
| Data Converters | www.national.com/adc | Distributors | www.national.com/contacts |
| Displays | www.national.com/displays | Green Compliance | www.national.com/quality/green |
| Ethernet | www.national.com/ethernet | Packaging | www.national.com/packaging |
| Interface | www.national.com/interface | Quality and Reliability | www.national.com/quality |
| LVDS | www.national.com/lvds | Reference Designs | www.national.com/refdesigns |
| Power Management | www.national.com/power | Feedback | www.national.com/feedback |
| Switching Regulators | www.national.com/switchers | | |
| LDOs | www.national.com/lido | | |
| LED Lighting | www.national.com/led | | |
| PowerWise | www.national.com/powerwise | | |
| Serial Digital Interface (SDI) | www.national.com/sdi | | |
| Temperature Sensors | www.national.com/tempsensors | | |
| Wireless (PLL/VCO) | www.national.com/wireless | | |

THE CONTENTS OF THIS DOCUMENT ARE PROVIDED IN CONNECTION WITH NATIONAL SEMICONDUCTOR CORPORATION ("NATIONAL") PRODUCTS. NATIONAL MAKES NO REPRESENTATIONS OR WARRANTIES WITH RESPECT TO THE ACCURACY OR COMPLETENESS OF THE CONTENTS OF THIS PUBLICATION AND RESERVES THE RIGHT TO MAKE CHANGES TO SPECIFICATIONS AND PRODUCT DESCRIPTIONS AT ANY TIME WITHOUT NOTICE. NO LICENSE, WHETHER EXPRESS, IMPLIED, ARISING BY ESTOPPEL OR OTHERWISE, TO ANY INTELLECTUAL PROPERTY RIGHTS IS GRANTED BY THIS DOCUMENT.

TESTING AND OTHER QUALITY CONTROLS ARE USED TO THE EXTENT NATIONAL DEEMS NECESSARY TO SUPPORT NATIONAL'S PRODUCT WARRANTY. EXCEPT WHERE MANDATED BY GOVERNMENT REQUIREMENTS, TESTING OF ALL PARAMETERS OF EACH PRODUCT IS NOT NECESSARILY PERFORMED. NATIONAL ASSUMES NO LIABILITY FOR APPLICATIONS ASSISTANCE OR BUYER PRODUCT DESIGN. BUYERS ARE RESPONSIBLE FOR THEIR PRODUCTS AND APPLICATIONS USING NATIONAL COMPONENTS. PRIOR TO USING OR DISTRIBUTING ANY PRODUCTS THAT INCLUDE NATIONAL COMPONENTS, BUYERS SHOULD PROVIDE ADEQUATE DESIGN, TESTING AND OPERATING SAFEGUARDS.

EXCEPT AS PROVIDED IN NATIONAL'S TERMS AND CONDITIONS OF SALE FOR SUCH PRODUCTS, NATIONAL ASSUMES NO LIABILITY WHATSOEVER, AND NATIONAL DISCLAIMS ANY EXPRESS OR IMPLIED WARRANTY RELATING TO THE SALE AND/OR USE OF NATIONAL PRODUCTS INCLUDING LIABILITY OR WARRANTIES RELATING TO FITNESS FOR A PARTICULAR PURPOSE, MERCHANTABILITY, OR INFRINGEMENT OF ANY PATENT, COPYRIGHT OR OTHER INTELLECTUAL PROPERTY RIGHT.

LIFE SUPPORT POLICY

NATIONAL'S PRODUCTS ARE NOT AUTHORIZED FOR USE AS CRITICAL COMPONENTS IN LIFE SUPPORT DEVICES OR SYSTEMS WITHOUT THE EXPRESS PRIOR WRITTEN APPROVAL OF THE CHIEF EXECUTIVE OFFICER AND GENERAL COUNSEL OF NATIONAL SEMICONDUCTOR CORPORATION. As used herein:

Life support devices or systems are devices which (a) are intended for surgical implant into the body, or (b) support or sustain life and whose failure to perform when properly used in accordance with instructions for use provided in the labeling can be reasonably expected to result in a significant injury to the user. A critical component is any component in a life support device or system whose failure to perform can be reasonably expected to cause the failure of the life support device or system or to affect its safety or effectiveness.

National Semiconductor and the National Semiconductor logo are registered trademarks of National Semiconductor Corporation. All other brand or product names may be trademarks or registered trademarks of their respective holders.

Copyright© 2008 National Semiconductor Corporation

For the most current product information visit us at www.national.com



**National Semiconductor
Americas Technical
Support Center**
Email: support@nsc.com
Tel: 1-800-272-9959

**National Semiconductor Europe
Technical Support Center**
Email: europe.support@nsc.com
German Tel: +49 (0) 180 5010 771
English Tel: +44 (0) 870 850 4288

**National Semiconductor Asia
Pacific Technical Support Center**
Email: ap.support@nsc.com

**National Semiconductor Japan
Technical Support Center**
Email: jpn.feedback@nsc.com